



- Model Year
2025
- Standard
- Lifted

NEXUS^{GEN 2}

USER

MANUAL



(866) 542-8677



support@bintelli.com

Introduction

Thank you for choosing Bintelli, welcome to the family. Your comfort and safety are very important to us, we strongly recommend that you read and follow the operating instructions in this manual, to avoid serious personal injury. Please make sure anyone operating your vehicle is familiar with the cart's functions.

Bintelli continually seeks advancements in product design and quality, therefore, while this manual contains the most current product information, please keep in mind there may be minor discrepancies between your actual cart and this manual. If you have any questions about your vehicle, please contact the dealership you purchased from or Bintelli directly.

Security Statements

Please pay close attention to the statements marked as “**Warning**”, “**Danger**”, and “**Caution**”. If any operating or safety warning sign on the vehicle is damaged, peeling, or blurred, it should be replaced immediately to prevent property damage, personal injury, or death.

This vehicle is limited to a certain number of passengers (including the driver). The number of passengers depends on the specific model, i.e. 2PR, 4PF, 4PR, and 6PR.

Warning

Failure to comply with all safety warnings may cause bodily injury to the vehicle operator and/or passengers.

- Keep the entire body in the vehicle when in motion.
- Do not operate while under the influence of drugs or alcohol.
- Make sure all passengers are securely seated before driving.
- Engage the parking brake when the cart is parked or unattended.

Danger

The batteries in your vehicle are capable of delivering large levels of power that can cause injury and even death. For your safety, never smoke near the vehicle. It should be stored away from sparks or flames. Only use the appropriate charger for your vehicle. When working on or near the battery, always wear eye protection, protective clothing, and gloves.

Operating the Vehicle

Prior to operating the vehicle, make sure you have consulted with state and local laws for the rules and regulations regarding who may legally operate the vehicle. Ensure the Tow/Run switch is set to the “Run” position. Place the vehicle in Neutral with the directional switch prior to turning the vehicle on. *Fully release the mechanical parking brake before operation. This will be either a foot operated parking brake on the 4 passenger models with rear facing seats, or a hand operated parking brake on the 6 passenger or the 4 forward facing seat models.* With the vehicle powered on and ready to use, turn the directional switch to the desired position (Forward or Reverse) to allow for vehicle operation in that direction.

Caution

Do **NOT** shift from Forward or Reverse while the vehicle is moving. This can damage the drivetrain.

Please note your vehicle has regenerative braking and will start slowing down when the accelerator is not pressed.

Exercise additional caution in areas such as:

- Steep slopes
 - Sharp bends
 - Blind spots
 - Wet or icy conditions
-
- Keep your entire body inside the vehicle, keep seated, and hold on while the vehicle is moving.
 - Do not start the vehicle until all occupants are securely seated with seat belts secured.
 - Do not start the vehicle while the vehicle is charging. Keep your hands on the steering wheel and your eyes on the path you are going.
 - Always back up slowly, and watch the rear of the vehicle carefully.
 - Avoid starting or stopping the vehicle suddenly.
 - Avoid turning the steering wheel abruptly at high speeds.
 - Always drive slowly up or down any incline.
 - Do not make any modifications or additions which may affect the capacity or safety of the vehicle.

Caution

All occupants should wear their seatbelts at all times when using the vehicle. Children should be seated between or next to an adult and protected by them when the vehicle is moving.

Vehicle Information

The VIN plate is located on the base of the seat as shown in **Fig. 1**. On a 4-passenger vehicle, the VIN plate is located on the base of the driver side. On a 6-passenger vehicle, the VIN plate is located on the base of the second row of seats.



Chassis Number

The Chassis number (also known as the serial number) is located on the passenger side behind the front wheel. It will be on a suspension of the cart, as pictured in **Fig. 2**



Turning the vehicle on

On the right side of the steering column is the start button, **Fig. 3**. The key fob must be within the vehicle in order to function, **Fig 4**. One short press will turn the vehicle on to the accessory position, allowing for use of your 12v accessories such as the sound system and lighting. A second short press in quick succession will power the entire vehicle, including the motor for normal operation. You may also skip the accessory mode and turn the vehicle on immediately by a long press of the power button. Simply hold the button until you hear an audible click, letting you know the system is powering on.



Dash Controls



- | | |
|---|--|
| <ul style="list-style-type: none">1. Combination Switch2. Charging Status Indicator3. Brake Pedal4. Accelerator Pedal5. Locking Glove Box | <ul style="list-style-type: none">6. 12v Power Outlet7. Directional Switch8. USB Charging Port9. Ignition Button10. Emergency Flasher Switch |
|---|--|

Combination Switch, Fig. 5

- Turn signals
 - Push up to turn on the right turn signal.
 - Push down to turn on the left turn signal.
- Headlights
 - Low beams
 - Pull towards you one click to turn on the low beam lights.
 - High beams
 - Pull towards you a second time to turn on the high beam lights.
- Horn
 - Press the horn button to activate the horn.



Parking Brake

The parking brake is located at the base of the front seat on 6 seat and 4 seat forward facing models, as pictured on **Fig. 6 and 7**. To engage the brake, pull up on the lever. To release, press the button on the handle in and lower the lever back down. On 4PR models, the parking brake is to the left of the brake pedal, near the bottom of the dashboard, as pictured in **Fig. 7**. To engage, press the pedal down while seated in the vehicle to engage the parking brake. To release, press the pedal down once more and allow the parking brake to return to its disengaged position.

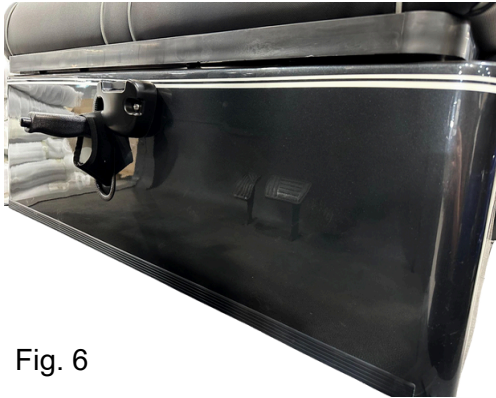

Fig. 6

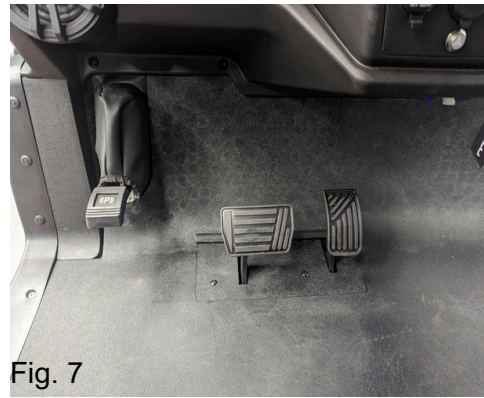

Fig. 7

Beach Chair Holder

The beach chair holder is located on the rear of the cart. All Nexus models with a rear facing back seat have the beach chair holder mounted to the rear grab bar, **Fig. 8**. For forward facing models, the holder is mounted on the rear roof support, **Fig. 9**. To open for use, pull the arm up and fold the support arm down to click into place. To close for storage, raise the arm slightly to remove pressure from the support arm. This will allow the support arm to be folded back into place, then fold it down.



Fig. 8



Fig. 9

Touchscreen Display

The touchscreen display communicates all of your Nexus' vital information and allows you to control all of the features of your cart, **Fig. 10**.

Home Screen



Fig. 10

1. Display Power Button	14. Multimedia Information Display
2. Volume Up Button	15. Battery Level Indicator
3. Volume Down Button	16. Speedometer
4. Play/Pause/Mute Button	17. Gear Selection Indicator
5. USB and 3.5mm Headphone Jack Under Cover	18. Odometer
6. Turn Signal Indicators	19. Amp Draw/Regenerative Braking Display
7. High Beam Indicator	20. Diagnostic Code Display
8. Low Beam Headlight Indicator	21. Ambient Lighting Power Button
9. Diagnostic Code Indicator	22. Ambient Lighting Mode Button
10. Parking Brake Indicator	23. Ambient Lighting Color Selection Button
11. Battery Warning Indicator	24. Ambient Lighting Color Selection Button
12. Brake Fluid Level Indicator	25. Home Button
13. Regenerative Braking Indicator	

Controls and Functions

With the home screen showing on the display, press the home button to access a menu that will allow you to control the features of your vehicle, **Fig. 11**. Touching the icons on this screen will take you to the associated menus to control the different functions and features included on your new Nexus.



Display Settings

Touching the Display Settings icon will display the screen to change the text and background colors, and change from MPH to KPH, **Fig. 12**. The buttons in the left of the screen will take you to the home screen or back one screen respectively.

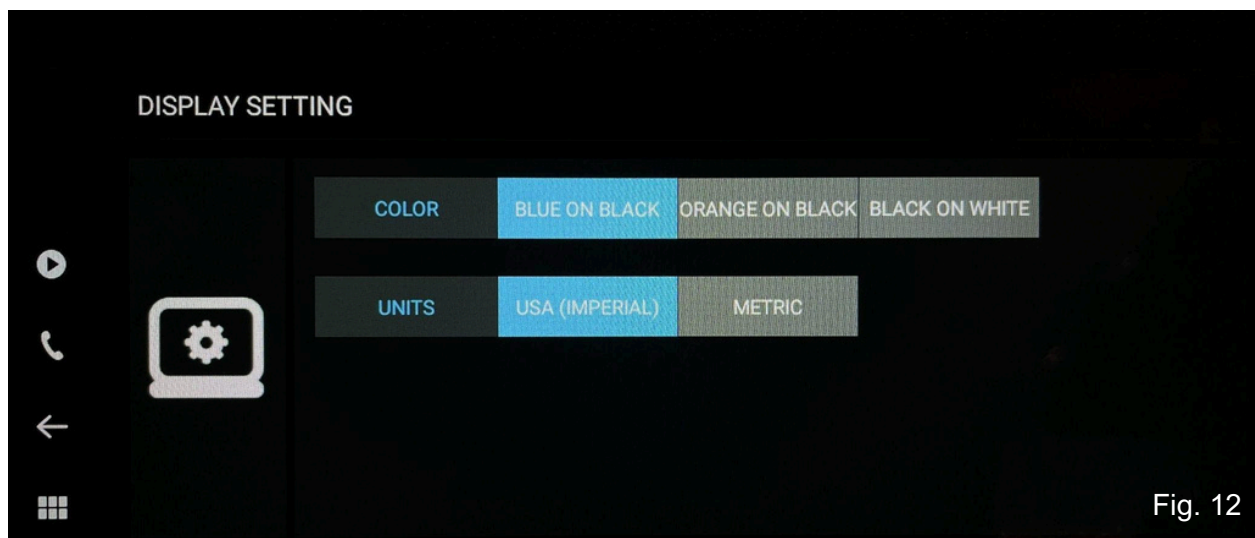

Ambient Light

Touching the Ambient Light icon will take you to a screen that controls your Nexus' ambient lighting, **Fig. 13**. Here, you can cycle the lights on and off, change modes, and change lighting color as desired. Touch the icons on the screen to make changes.

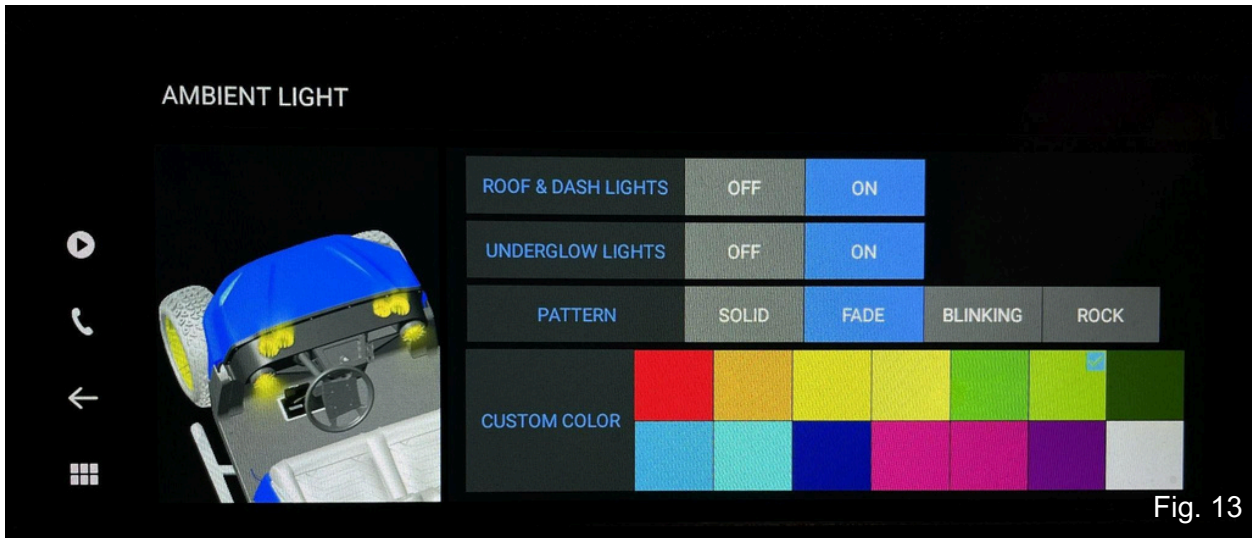

Vehicle Roof

Touching the Vehicle Roof icon will display a screen that controls the features of your Nexus' roof, **Fig. 14**. Touch ON or OFF to turn the vehicle's fans and overhead logo lighting on or off, **Fig. 14a**. The dome light mounted above the driver's seat is turned on and off by touching the center of the light, **Fig. 14b**. To dim the dome light, press and hold the on/off button on the light itself.

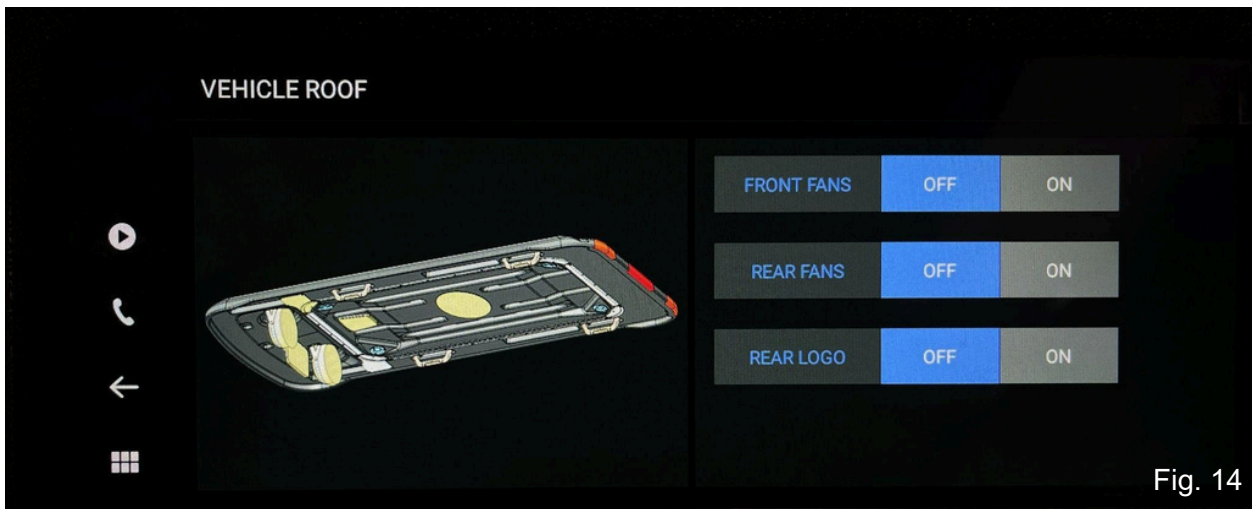



Vehicle Settings

Touching the Vehicle icon will display the Trip reset buttons, **Fig.15**.

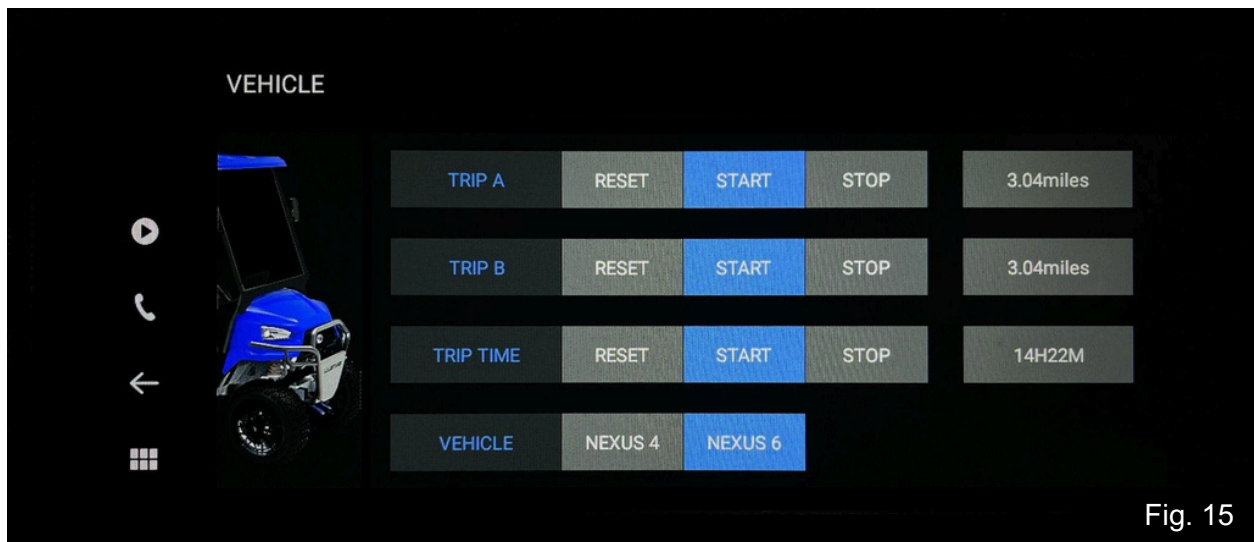

Fig. 15

Bintelli Auto/Carplay and BT (Bluetooth) Music

Touching either of the BintelliPlay (**Fig. 16**) or BintelliAuto (**Fig. 17**), icons will display their respective screens to connect a supported device. Touching the BT Music icon (**Fig. 18**) will bring up your Bluetooth management settings. To connect a Bluetooth device, open the Bluetooth settings menu on the device you wish to connect, scan for devices, and then select NEXUS from the list of available devices. Follow the prompts on your device, and when it is successfully connected the device's name will be displayed on the Nexus screen.



Fig. 16



Fig. 17



Fig. 19

Radio

Touching the Radio icon will display the to change radio station, scan for presets, and adjust the settings for sound, **Fig. 20**.

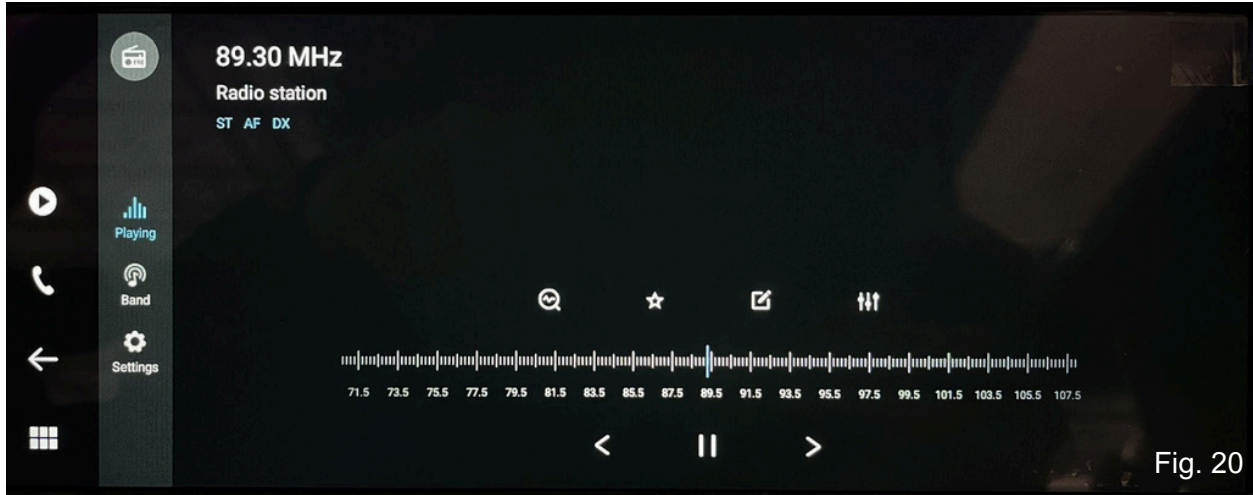

Fig. 20

Settings

Touching the Settings icon will display the screen to adjust the display brightness, check for Bluetooth connection, WIFI IP, change language, and check system versions, **Fig. 21**.

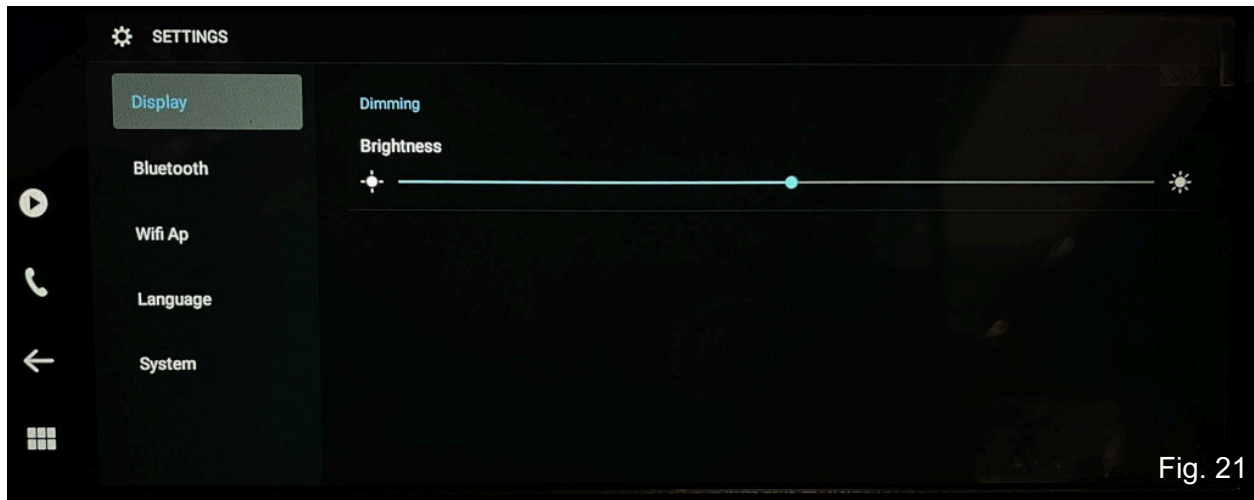
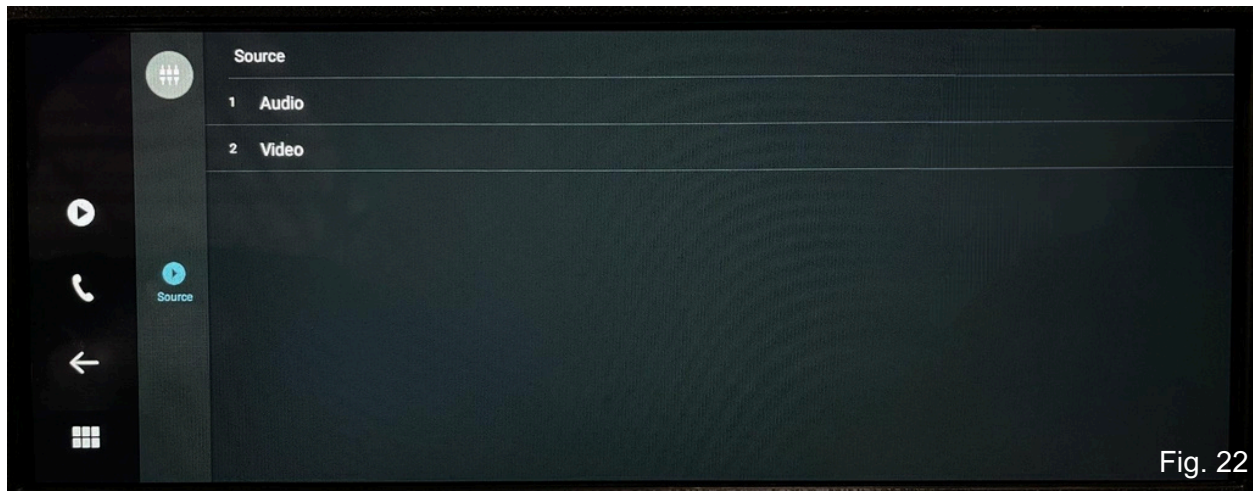

Fig. 21

AUX

Touching the AUX icon will display the auxiliary on screen for a 3.5mm audio jack input. Note: this feature will not display song information, **Fig. 22.** (Please note: Currently no video input.)



Tow/Run Switch (Off/On Switch)

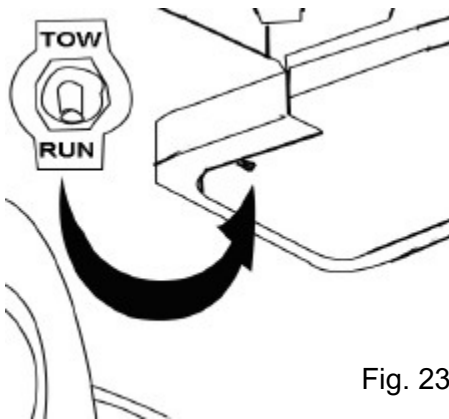

Before operating the vehicle, make sure the Tow/Run switch is in the “Run” position. When towing or pushing the vehicle flip the switch to the “Tow” position, **Fig. 23.**

Warning

Attempts to physically move the vehicle while in the “Run” position will damage the motor and electrical components of the cart. This can result in a fire hazard, so always ensure the vehicle is in the TOW position prior to pushing or towing the vehicle.

Safe Operation Instructions

Your Nexus is designed with simplicity in mind. However, please make sure to observe the following safe operation instructions. As with any new vehicle, always familiarize yourself with the location and function of all vehicle controls. Always perform checks on the battery, tires (recommended tire pressure is 30 psi), body/chassis, brakes, parking brake, and steering prior to operating the vehicle.

Caution

Always ensure the vehicle is powered OFF before performing any inspections of the vehicle components.

- Only authorized drivers should have access to the vehicle.
- Only drive this vehicle where allowed by law and/or local regulations. When in doubt, contact your local DMV for guidance on where the vehicle can operate.
- Do not overload the vehicle, otherwise, damage to the motor and electrical systems may occur. Additionally, overloading the vehicle can cause vehicle instability leading to loss of control and increased risk of danger.
- Do not operate the vehicle under the influence of alcohol or drugs.
- Do not attempt to use vehicles on uphill/slopes beyond its grade climbing ability.
- Exercise additional caution at crossroads, blind areas, or when encountering unsafe conditions.
- **ALWAYS** engage the parking brake when getting out of your vehicle to ensure the vehicle does not roll and create an unsafe condition

Storing and Charging

If the vehicle needs to be stored for an extended period of time, perform the following actions:

- Fully charge the battery utilizing the supplied charging cord.
- Turn the "Tow/Run" switch to the "Tow" position.
- Turn off battery power with the red button on the battery's BMS.
- Store the key fob in a safe place away from the vehicle. Ensure the tire pressure is set to 30 psi.
- Clean the body, seats, battery box, and chassis with appropriate cleaning materials.
- If storing outdoors, cover the vehicle with a storage cover.
- Check and charge the battery at least every few months, as the battery will naturally discharge over long periods of time.
- Monitor the battery cables for corrosion.
- Store the battery in a well-ventilated area with temperatures between 41°F and 104°F

Maintenance

The appropriate care must be used when performing maintenance, service, or accessory installation. Only trained technicians should service or repair the vehicle and/or battery charging system.

Warning

Before any service work to the battery pack,, the Tow/Run switch must be in the “Tow” position. Failure to comply with this warning may result in battery failure leading to serious personal injury.

- When maintaining the vehicle or batteries, do not wear loose clothing or conductive jewelry such as rings, watches, and bracelets.
- Insulated tools need to be used when working near the battery or power connections to prevent electrical damage.
- Before working under the cart, ensure the parking brake is engaged, the cart is switched into the “Tow” position, and the key fob is away from the vehicle.
- Please keep all signs, warnings, and instructions provided by the manufacturer clear and untampered.

Battery Operation

The battery pack’s power button is located on the Battery Management System module (BMS), **Fig. 24**. For 4 seat models equipped with a 105ah battery, the BMS is located on the passenger side of the battery. To turn the battery on, press the red “on/off” button, **Fig. 25**. In the ON position, the button will be recessed. After pressing the red “on/off” button, press and hold the green “start” button for a few seconds. The battery will now supply power to the vehicle. To turn the battery off, push the red “on/off” button again. In the off position, the button will no longer be recessed.

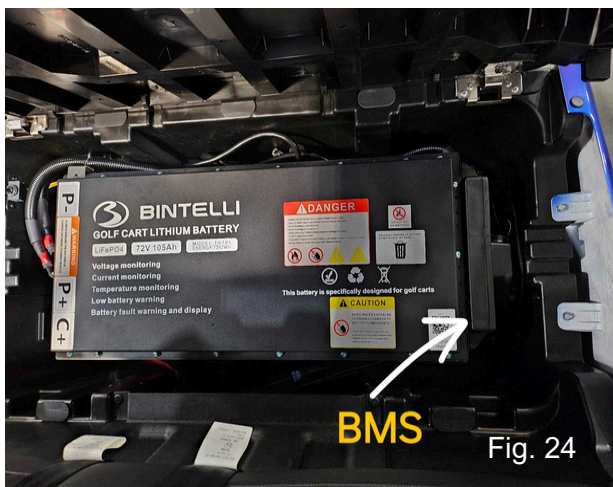

Fig. 24



Fig. 25

The 6 seat model is equipped with a 165ah battery pack, the BMS is located in the battery compartment under the seat back in the battery compartment row of seats, **Fig. 26**. To turn the battery on, press the red “on/off” button, **Fig. 27**. In the ON position, the button will be recessed. After pressing the red “on/off” button, press and hold the green “start” button for a few seconds. The battery will now supply power to the vehicle. To turn the battery off, push the red “on/off” button again. In the off position, the button will no longer be recessed.



Fig. 26

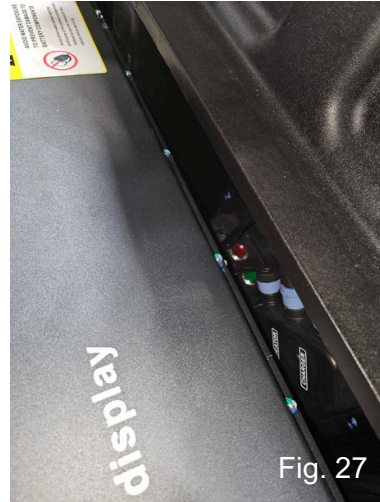

Fig. 27

Please note: Full battery power and range is available after 5-7 full battery cycles. You will notice the range increase after each charging cycle when the vehicle is new.

If your Nexus will not be used for a period of 7 days or more, turn the battery off after use.

Important Notice

Before performing any maintenance to the batteries, it's essential to cut all power to the vehicle. **To turn off the power supply, make sure the cart is in park, turn the Tow/Run switch to “Tow”, and remove the key fob from the vehicle..** Once this has been completed, routine maintenance may begin.

Always keep sparks and flames away from the battery, including smoking near the vehicle.

Cleaning

Batteries can attract dust, dirt, and grime. Keeping them clean will help you spot signs of trouble if they appear, and avoid problems associated with grime and corrosion.

Charging

To charge your Nexus battery, first ensure the ignition is in the off position, then insert the included charging cord into the battery charger power port located on the base of the battery compartment. Once plugged in, the battery charger will automatically charge the battery, and then turn off once the charge cycle is completed. When power is connected to the battery charger, the vehicle's display screen will show current battery percentage for a short period of time, and then revert to standby mode. To get this to show again, unplug the battery charger, wait 30 seconds, and then reconnect. There is also a battery charger status light on the dashboard. The chart below shows what the charging light represents, for more detailed information, please refer to the charger manual.

Charging Tips

1. Do not plug in, or unplug the charger while the vehicle's ignition is on.
2. A dedicated 20 amp circuit is required for battery charging.
3. If the distance to your power source is greater than the length of the included charging cord, only use a 10 gauge or larger extension cord of no more than 25'.
4. The battery system will charge regardless of whether the battery is on or off.

The battery should be recharged each day and or after the vehicle is used. Lithium batteries do not have a "memory" and should not be allowed to fully discharge.

Indicator Beacon	
Battery Indicator	Charging: Green blinking light Fully Charged: Green solid light
Fault Indication	Overvoltage: Red Green Red Overheating: Green Red Output under voltage: Red Green Input AC anomaly: Red Green Red Green Red Integrated fault: Green Red Green

Lithium Battery Care

Warning

Do not touch or attempt to secure terminal connection until the power is completely shut off to the vehicle. To disengage power, turn the tow/run switch to “tow”, remove the key fob from the vehicle, locate the power button on the lithium battery and switch it “off” (Power button shown on Figure 3). The Power switch on the battery must be **OFF** before any servicing of the battery or cables.

Lithium Battery Maintenance:

- Clean cables and ensure the surface is free of moisture or contamination.
- Checking cables and ensure battery connections are secure.
- Ensure battery receives charge.
- Monitor battery during extended periods of inactivity, long term storage, and colder temperatures.

Although Lithium batteries do not require the same type of routine maintenance as traditional Lead Acid, it is still strongly recommended to use the proper suggested care to maintain their efficiency. This includes the Lithium Checklist and more detailed information noted in the user manual.

It's important to be aware that improper management can void your battery warranty and cause further issues with the service of your vehicle.

For additional questions and customer support, please contact your local dealer or Bintelli directly.

Regular Maintenance Checklist

C=Check, CA=Check/Adjust, R=Replace, S=Perform, CL=Clean/Lubricate						
	Before Use	Every month/20 hours/ 100 miles	Every 6 months/125 house/600 miles	Every year/250 hours/1200 miles	Every 2 years/500 hours/2500 miles	Every 4 years/1000 hours/5000 miles
Battery Charger	S	S	S	S	S	S
Clean Batteries	S	S	S	S	S	S
Check Brakes	C	CA	CA	CA	CA	CA
Check Steering	C	C	C	C	C	C
Check Tires	C	CA	CA	CA	CA	CA
Check Body	C	C	C	C	C	C
Battery Discharge Test				S	S	S
Replace Rear Axle Lubricant				R	R	R
Clean and Lubricate Pedals		CL				

Client Responsibilities

Battery Cables – Tighten battery cables per battery manufacturer instructions located on battery. Failure to verify connections once a month could result in damage to the batteries. BEFORE placing the vehicle into service, please check all battery cables and tighten as they may become loose due to turbulence in shipping.

Charger Power Cord – Do not remove the manufacturer tag on the power cord as doing so will void the warranty. Always unplug the charger before turning the vehicle on.

Charging – Each charger must have a dedicated circuit with 20 amps. The vehicle should be left plugged in when not in use. The charger will trickle charge when needed. Improper charging will lower the range of the vehicle and over time cause premature damage to the battery.

Extension Cords – We do not recommend using an extension cord to charge. If you do use one, it must be heavy-duty (10 gauge) as the extension cord will determine how many amps the charger will receive.

Parking Brake – All vehicles have a parking brake (hand or foot). Driving with a parking brake engaged will damage the motor and braking systems and can create a fire hazard. Always disengage the parking brake before driving.

Storage – Vehicles should NOT be left out in the elements.. We recommend storing covered in a garage environment in order to preserve the integrity of the paint and fit/finish of the vehicle. When garage storage is not possible, it's recommended to use a vehicle storage cover to maintain the condition of the vehicle.

Tires – Must be inflated to proper capacity. Upon delivery, please check all lug nuts and tighten them as they may become loose due to turbulence in shipping. Additionally, check lug nut tightness once a month.

Tow Switch – Must be pointed to “Run” and not “Tow” to operate. Must be in “Tow” position if towing.